

# Plastic Products for the Heavy Duty Truck Market

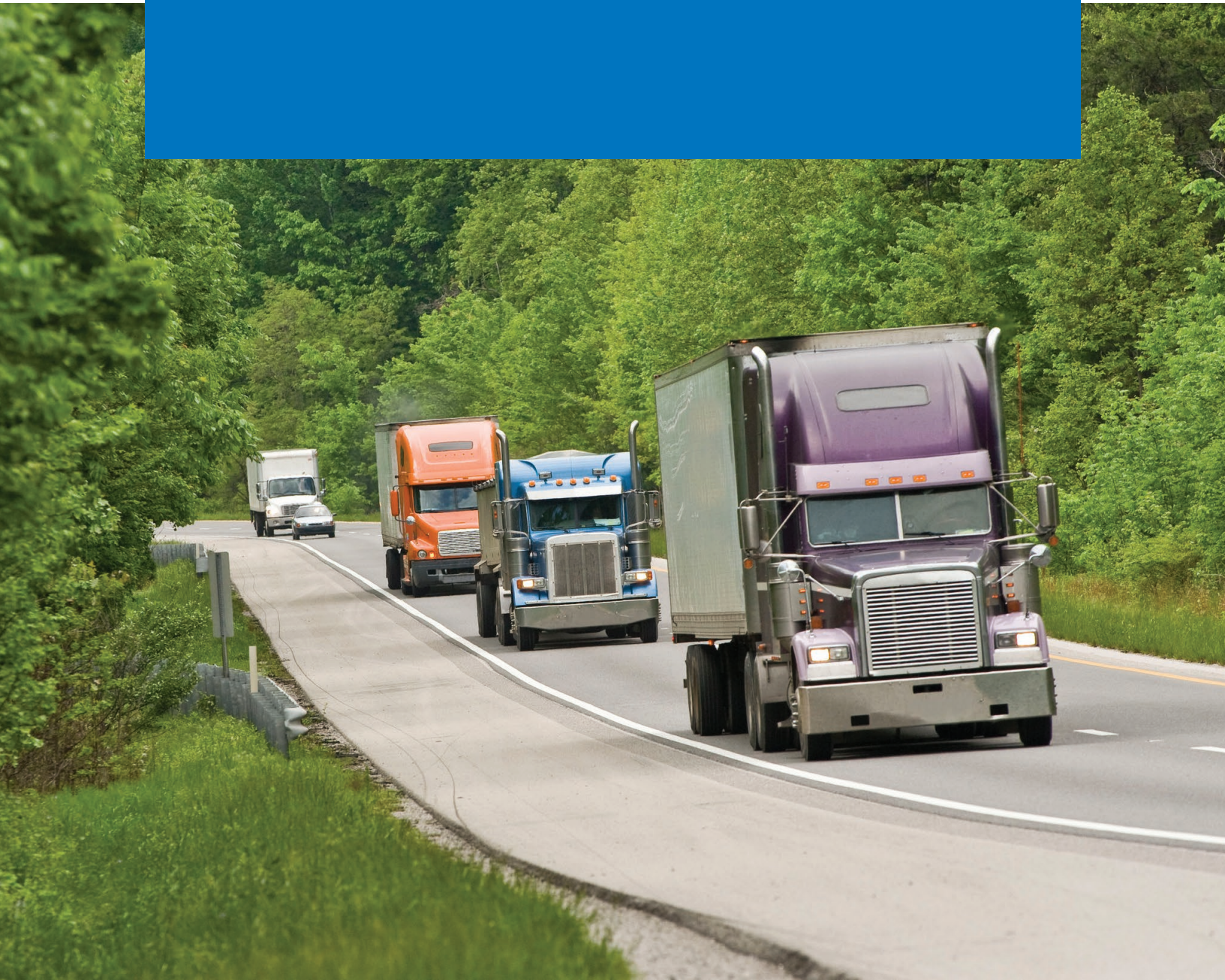

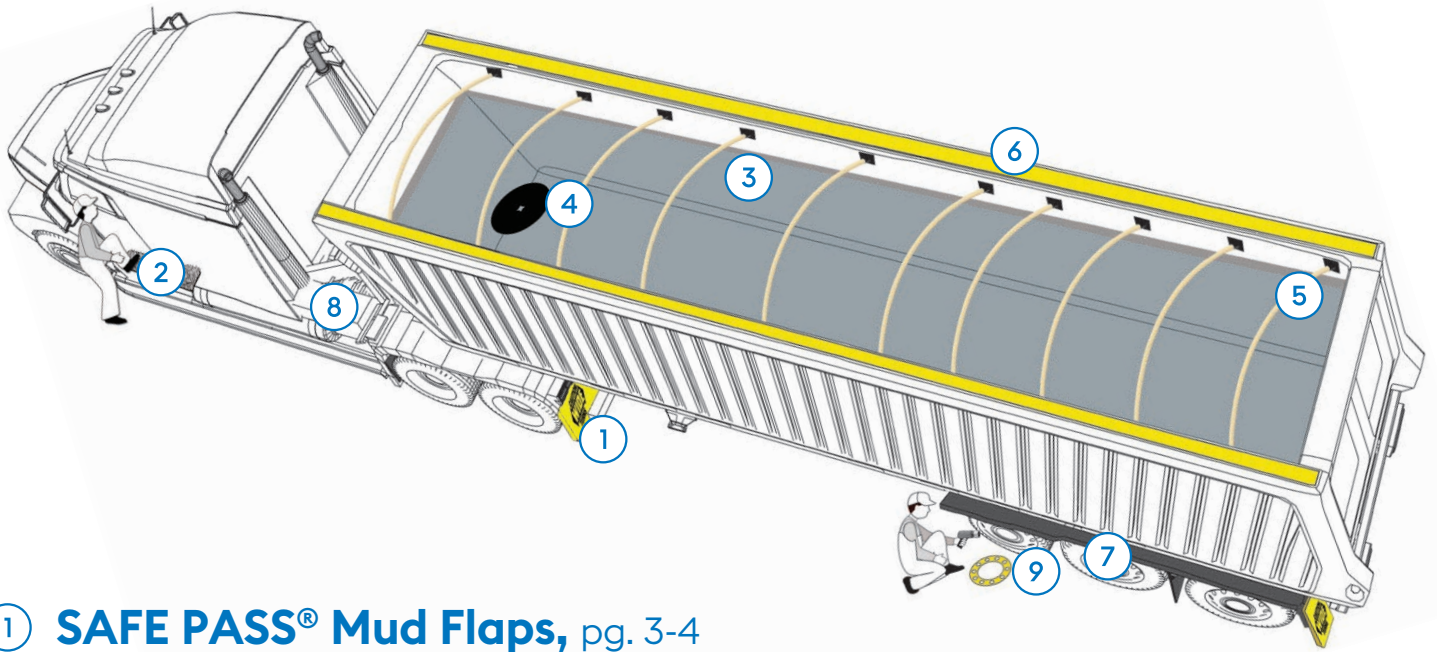

① **SAFE PASS® Mud Flaps**, pg. 3-4

② **Sym-Mat® Boot Cleaning Mats**, pg. 7

③ **Polystone® Lining Systems**, pg. 5-6

④ **5<sup>th</sup> Wheel Lube Disk**, pg. 7

⑤ **Flexible Nylon Tarp Bows and Brackets**, pg. 6

⑥ **UHMW Slide Strips**

UHMW-PE strips protect a sliding tarp system from damage. Available in ¼" x 2" and ¼" x 1½".

⑦ **Tandem Fender**

Durable polyethylene fenders, custom lengths and multiple colors available.

⑧ **Quarter Fender Top Flap**

24" x 6" poly fender top flaps are available, either plain or with customized logo, in several thicknesses and styles.

⑨ **HDPE Wheel Protector**

13½" diameter ring used to protect aluminum wheels during repairs or installation.

# 1 SAFE PASS® Mud Flaps

Roechling sets the standard for poly flaps. Our mud flaps will not curl like less expensive plastic flaps and will flex only as much as needed, but always return to vertical to hang straight.

## SAFE PASS® Anti-Curl Smooth (.170")

SAFE PASS® Anti-Curl Smooth is made from UV-stabilized polyethylene resin to produce a durable yet flexible flap that does not curl and maintains integrity at temperatures between -20° F and 170° F.

poly or  
hybrid  
rubber

## SAFE PASS® Grooved (.240" or .340")

Made from the same polymer resins as SAFE PASS® Smooth, our grooved flap is heavier and includes a ribbed, spray-reducing surface on the tire side. Also available in hybrid rubber design in thicknesses of ¼", ⅜", and ½".

## Spray Guard®

This is the best-constructed and most effective anti-spray flap in the transportation industry. The artificial grass surface captures road spray and channels the water downward, reducing splash and spray by up to 80%. This unique design improves visibility for both the truck's driver and trailing vehicles. It also keeps equipment cleaner and maintains integrity at temperatures between -20° F and 170° F.

## SAFE PASS® Aero

More than 30 years of proven spray suppression technology combined with a new aerodynamic design create a revolutionary mud flap for the heavy duty truck market. SAFE PASS® Aero features a low-spray grass backing and vents for increased aerodynamics.

### ALL FLAPS ARE NOW AVAILABLE IN 18" WIDTH FOR WIDE BASE TIRE CONFIGURATION.

These narrow mud flaps for super single wide based tire configurations reduce unwanted drag by matching the mud flap to the tire width.

*Upgrade your mud flaps with either of our custom imprinting options.*

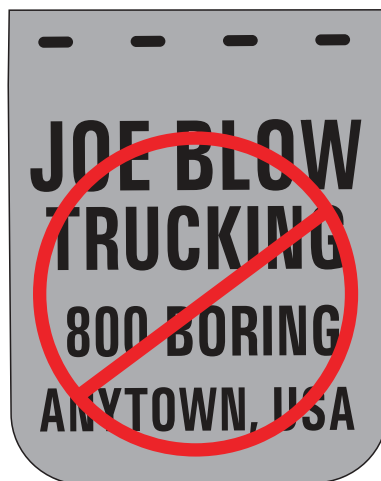











We like to think of mud flaps as mini mobile billboards, so why waste the space when you can showcase your brand with custom imprinting?

# SAFE PASS® Mud Flaps

## Roehling offers custom logos using two printing processes:

1. Silk Screen Printing on plastic: allows for complex designs that can feature half-tone effects (*only available on plastic flaps*) with minimal set-up fees
  2. Hot Stamping on rubber or plastic: for more basic designs and larger volume runs
- Both processes are guaranteed for one year against fading and peeling.*

### Standard Hot Stamping Foil Colors

 Dark Red PGS-460-1	 Green PGS-727-1
 Dark Blue PGS-640-1	 Chrome B5E-50
 Medium Blue PGS-670-1	 Gold AB20-PV
 Light Blue PGS-624-1	 Burgundy PGS-405-1
 Yellow PGS-320-1	 Gray PGS-960-1

### Standard Screen Printing Ink Colors\*

 White 9100-01	 Dark Green 91-S-144
 Black 9700-70	 Dark Blue 91-S-150
 Lemon Yellow 91-S-112	 Light Blue 91-S-158
 Medium Yellow 91-S-116	 Medium Blue 91-S-159
 Orange PMS 165C	 Fuchsia 91-S-182
 Bright Red 91-S-126	 Gold 9720 RPG
 Dark Red 91-S-128	 Silver 8180 C
 Light Green 91-S-142	

\*Custom ink matching available

SAFE PASS® .170" smooth, anti-curl poly			
Non-decorated			
Size	Part Numbers		Wt. (lbs)
	White	Black	
24" x 24"	10938	10934	3.5
24" x 30"	10959	10955	4.3
24" x 36"	10975	10971	5.2

SAFE PASS® .240" grooved, low spray poly			
Non-decorated			
Size	Part Numbers		Wt. (lbs)
	White	Black	
24" x 24"	12968	12976	4.0
24" x 30"	12972	11876	5.0
24" x 36"	12974	12979	6.0

SAFE PASS® .340" grooved, low spray, anti-curl poly			
Non-decorated			
Size	Part Numbers		Wt. (lbs)
	White	Black	
24" x 24"	11473	11471	4.0
24" x 30"	11483	11481	5.0
24" x 36"	11493	11491	6.0

SAFE PASS® .240" low spray, hybrid rubber			
Non-decorated			
Size	Color	Part#	Wt. (lbs)
24" x 24"	Black	101325	4.4
24" x 30"	Black	101326	5.5
24" x 36"	Black	101327	6.6

SAFE PASS® .340" low spray, hybrid rubber			
Non-decorated			
Size	Color	Part#	Wt. (lbs)
24" x 24"	Black	101328	6.2
24" x 30"	Black	101329	7.8
24" x 36"	Black	101330	9.4

SAFE PASS® .460" low spray, hybrid rubber			
Non-decorated			
Size	Color	Part#	Wt. (lbs)
24" x 24"	Black	101331	8.4
24" x 30"	Black	101332	10.5
24" x 36"	Black	101333	12.6

SAFE PASS® Aero grass backed, anti-spray, aero dynamic poly			
Size	Color	Part#	Wt. (lbs)
24" x 24"	Black	107664	4.8
24" x 30"	Black	107665	6.0
24" x 30" L	Black	107662	5.8
24" x 30" R	Black	107663	5.8
24" x 36"	Black	107666	7.2

Spray Guard® grass backed, anti-spray, anti-curl poly			
Non-decorated			
Size	Part Numbers		Wt. (lbs)
	White	Black	
24" x 24"	11154	11152	5.0
24" x 30"	11166	11162	6.5
24" x 36"	11176	11174	8.0

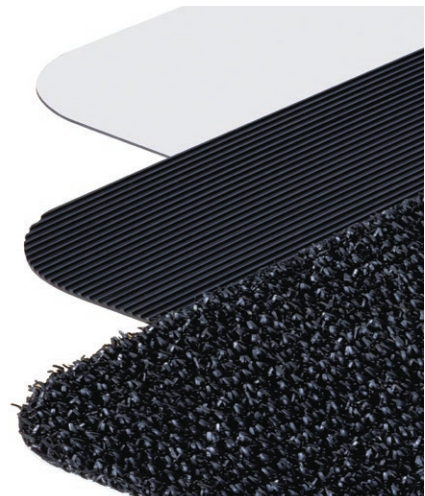

All flaps other than SAFE PASS® Aero are available with custom logos. Contact Roehling for the appropriate part and artwork numbers. Radius bottom corners and slotted bolt holes are standard on plastic flaps. Square bottom corners and slotted bolt holes are standard on rubber flaps.

### 3 Polystone® Lining Systems

Polystone® and Matrox® liners from Roechling Industrial North America are affordable, non-stick poly liners that stand up to the most extreme lining conditions. These products deliver a self-lubricating, impact-resistant polymer surface with mechanical properties that make them ideal for most truck lining applications. The low surface friction eliminates load sticking and as a result will provide even load release during every dump cycle. This will protect your fleet from dangerous tip-overs by reducing dump angles by up to 50%. Other benefits include longer service life from your brakes, hydraulic hoist and bed surface.



#### Matrox® UHMW (Ultra-High Molecular Weight)

Our premier liner is designed for sticky, high temp loads like asphalt (400° F max for 1/2" thick) and non-asphalt loads (200° F max for 1/4" and 3/8" thick material). Matrox® has all the impact strength and abrasion resistance of our other aggregate grade liners, but is designed to withstand short-term spikes in temperatures as high as 350° F. Matrox® also has a proprietary silicone additive that basically eliminates sticking from the most stubborn loads. Standard color is gray. Five year warranty, contact Roechling for warranty details.



#### Polystone® Extreme Wear UHMW (Ultra-High Molecular Weight)

Our premium grade liner for moderate temperature loads. Polystone® Extreme Wear is designed for extreme loads with above normal impact and abrasion. It is ideal when hauling large stone, scrap steel/glass and demolition. Standard color is a bluish gray. Five year warranty, contact Roechling for warranty details.



#### Polystone® Aggregate UHMW (Ultra-High Molecular Weight)

Our most popular grade of material. Polystone® Aggregate is slick enough for most loads, economically priced, and offers fantastic abrasion and impact resistance. It is the perfect liner for hauling common aggregate materials such as coal, crushed stone, gravel, grain, sand, and other moderate temperature abrasive loads. Standard color is black. Three year warranty, contact Roechling for warranty details.



#### Polystone® Medium Duty HMW (High Molecular Weight)

Our economy liner designed for applications that do not require significant toughness. Polystone® Medium Duty is a great liner for loads that are primarily sticky and not typically damaging, such as topsoil, animal waste, and mulch. Available in black or white (natural UV). One year warranty, contact Roechling for warranty details.



Matrox® UHMW (Ultra High Molecular Weight), our premier liner for high temp applications.

# Liners and Dump Trailer Accessories

Roechling dump liners eliminate the need for bed scraping. They also reduce the dump stages required to unload, minimizing the risk of rollover while unloading.

The 16 foot wide liner shown is the largest available in the industry.



Note how the wet top soil sticks to the bed. Hundreds of pounds of material can get stuck, and scraping beds is time-consuming, dangerous work. Using heavy equipment to scrape the bed can also cause damage. With Roechling lining systems, you never need to scrape a bed.



Polystone® liners can reduce the dump angle required for a load to release by as much as 50%. Note this trailer has completely dumped a load of gravel in only 3rd of the 5 available hydraulic stages. This minimizes the time required to unload, meaning more load capacity per day. Polystone® liners pay for themselves in a matter of weeks after installation.



Lower dump stages reduce the chances of rollover accidents due to load hangup. They also minimize the chances of equipment striking overhead obstructions such as power lines and trees.

## 5 Flexible Nylon Tarp Bows and Brackets

Traditional tarp bows are made of steel or aluminum and can be easily damaged during loading. Roechling tarp bows are less likely to be damaged because they flex then spring back into original form with little or no damage.

Brackets are designed to be either welded or bolted into place and include a drain port. Available in both steel and aluminum. Unlike other polyethylene bows, Roechling bows withstand temperatures ranging from -20° F to 170° F.

Nylon Tarp Bows	
Size	Part Number
101 in.	RENYVNATNOA01375101
120 in.	RENYVNATNOA01375120

*Standard lengths are 101" and 120", but custom lengths are available.*

Tarp Bow Brackets	
Socket	Part Number
Aluminum	181333
Steel	181334



Nylon bows are less likely than traditional tarp bows to be damaged from impact with large stones or heavy equipment.

## Accessory Products

NEW  
ringless  
design



### “Ringless” 5th Wheel Lube Disk *eliminates the need for a steel retaining ring*

The new ringless design of our 5th wheel lube disk allows for an easier, more secure installation and eliminates the need for extra replacement rings. Made of curl-resistant polymer with a slip agent additive for extra lubrication, it will not sag after installation, reducing the chance of damage during hook-up. The disk features a tighter inside diameter for a more consistent installation, even on older king pins, and stays in place for a dozen or more “un-hooks” where a traditional disk might fall off after only one.

Part #	Description	Wt.
NEW DESIGN that requires no steel retaining clip		
108357	32" disk, no steel ring required	5 lbs

traditional  
design  
with steel  
ring



### Poly 5th Wheel Lube Disk with Steel Retaining Ring

This slip agent impregnated poly disk replaces the grease commonly used between the truck’s 5th wheel and the trailer’s king pin plate. It includes a steel retaining ring that fits standard 2.875” king pins only.

*NOTE: This lube disk is intended for use on trailers with a standard 2.875” diameter king pin, which is not worn or undersized. Always ensure a successful lock between the 5th wheel and king pin prior to any trip.*

Part #	Description	Wt.
Traditional 5th wheel lube disk with steel retaining clip		
13175	32" diameter disk with steel ring	5 lbs
13176	replacement steel ring only	24 oz



### Sym-Mat® Boot Cleaning Mats

Sym-Mat® grass door mats for heavy-duty trucks install in seconds with the included tie straps. No additional hardware or tools required.

Sym-Mat® provides a low-profile cleaning surface, which reduces dirt and debris inside of the cab and provides a safer step surface for the driver.

Comes with heavy-duty Ty-Raps for easy installation.

Part Number	Size	Grass Color
11364SYM	4.5" x 24"	Black
105844	5" x 16"	Black

#### North American Headquarters

**Roechling Industrial Gastonia**  
903 Gastonia Technology Parkway  
Dallas, NC 28034 | USA  
Tel. +1 704 922-7814  
Fax +1 704 922-7651  
info@roechling-plastics.us  
www.roechling.com/us/industrial

#### Canada

**Roechling Industrial Orangeville**  
21 Tideman Drive  
Orangeville, Ontario L9W 3K3 | Canada  
Tel. +1 519 941-5300  
Fax +1 519 941-4489  
info@roechling-plastics.ca  
www.roechling.com/us/industrial

**Roechling Industrial.** Empowering Industry.  
[www.dumpliner.com](http://www.dumpliner.com)

© 2023 Roechling Industrial Gastonia. All rights reserved.  
© 2023 Roechling Industrial Orangeville. All rights reserved.

