



**Machined Components
made of engineering
plastics**





Contents

Röchling Group	2
Business Unit Machined Components	2
Global presence	3
Competence in machining	
Overview of our processes	4
Unlimited possibilities	6
Competence in materials	
Competence in Plastics	8
An unparalleled range	9
Research and development	10
Competence in industry	
Understanding customer applications	11
Engineering and plant construction	12
Beverage industry	13
Paper industry	14
Food industry	15
Conveyor technology and automation	16
Healthcare	17
Electronics	18
Water and Harbor Construction	19
Bulk material handling	20
Agricultural technology	21
Special vehicle construction	22
Sports and leisure industry	23
Renewable energies	24
Oil & Gas	25
Aerospace	26
Legal information	27

Competence in Plastics

The Röchling Group, which is headquartered in Mannheim, includes a large number of locations in countries all over the world. With a workforce of several thousand employees, we manufacture our products in close proximity to our customers and markets. Our three company divisions, Industrial, Automotive and Medical, generate billions in sales every year on the European, American and Asian continents.

Röchling Industrial

The Industrial division supplies almost every sector of industry with optimal, application-oriented materials. To achieve this, Röchling has probably the world's biggest product portfolio of thermoplastics and composite materials. The company manufactures a range of semi-finished parts such as sheets, rods, tubes, flat bars, finished castings and profiles as well as machined and assembled precision components.

Everywhere close to you

Within the Industrial Division, the Business Unit Machined Components has over 1000 employees and is the world-wide leader in machining plastics. The flexible companies have specialised in the manufacture of high quality machined components for virtually every sector of the capital goods industry. We develop optimum solutions jointly with the customer, then realise them efficiently.

Your ideas become high quality components

This one-of-a-kind, international network of companies provides you with the material expertise of one of the most innovative manufacturers of semi-finished plastic parts, as well as outstanding industry know-how and machinery that is unparalleled in the world.

You benefit from the synergies of the global locations of the Business Unit. We look forward to meeting your most challenging needs.

www.roechling.com

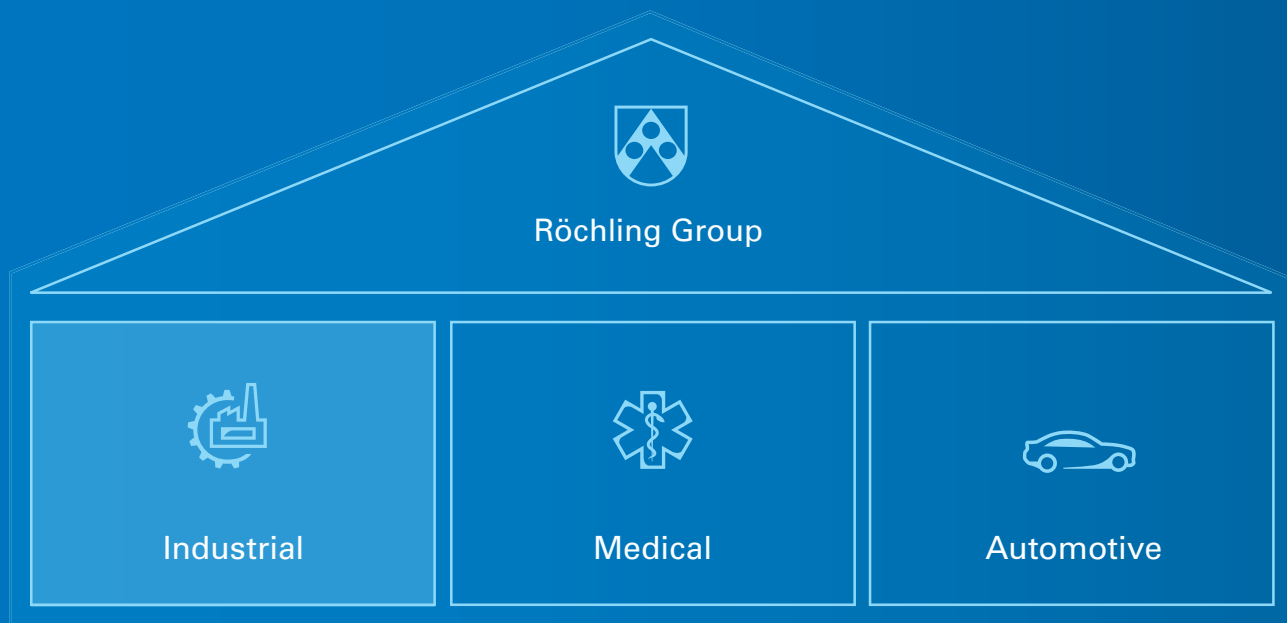

Röchling Group Global presence: 90 locations in 25 countries



Overview of our processes

Flexible, powerful, precise

The machining companies of the Röchling Group provide you with virtually unlimited processing possibilities and a leading manufacturer with one-of-a-kind installations and machinery. We have invested in the most modern technology and thus, provide top quality with reliable tolerances and outstanding surface quality.

We have modern, high-performance CNC machining centres. Large-size CNC milling machines offer the possibility of producing products in the largest dimensions with narrow tolerances.

For our customers this means:

- High degree of material utilisation
- Reduced assembly times
- Fewer welding seams
- Narrow length tolerances

Worldwide largest processing centre
 Over 100 CNC milling machines
 State-of-the-art process technologies



Planing

Straight planing

- Length: max. 12,000 mm
- Width: max. 2,500 mm



Sawing/Blank Cutting

- Dividing saws for panels
- Band saws for rods and tubes
- Round blank saws



Milling

- Length: 1 – 14,000 mm
- Width: 1 – 2,500 mm
- Thickness: 1 – 730 mm

Round components

Ø up to 3,500 mm

Larger dimensions available upon request



Turning

Ø 2 – 2,000 mm

Large-size turned parts

Ø max. 2,000 mm

Length: max. 800 mm

Tubes

Ø max. 750 mm

Length: max. 2,300 mm



Profiling

- Length: max. 12,000 mm¹⁾
- Width: max. 235 mm
- Thickness: max. 165 mm

¹⁾ > 12,000 mm

see profile extrusion



Profile Extruding

Polystone® M (PE-UHMW)

> 700 pcs. tools

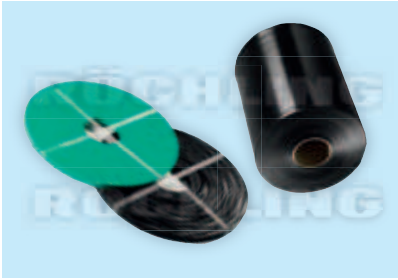

Skiving

Strip material

Polystone® M (PE-UHMW)

- Width: max. 100 mm
- Thickness: 1-8 mm

Films

- Thickness: 0,25-3 mm
- Width: 100-300 mm
- Length: 11-136 m

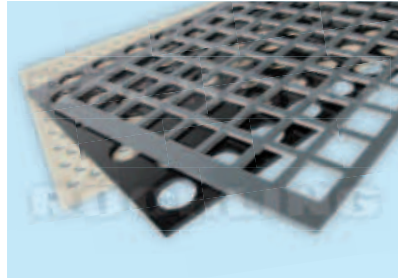

Punching

- Length: continuous
- Width: max. 1,500 mm
- Thickness: up to 8 mm

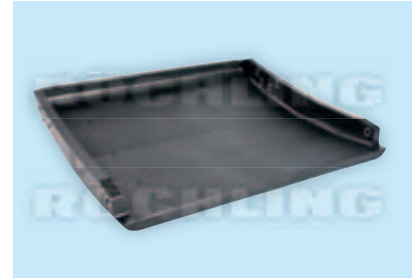

Thermoforming

- Length: max. 1,600 mm
- Width: max. 1,200 mm
- Panel thickness: max. 30 mm

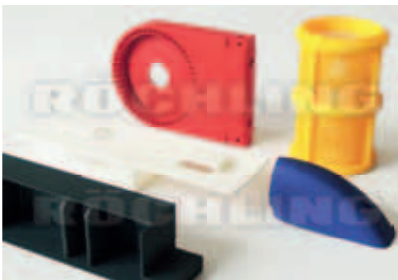

3D printing

- Selective laser sintering



Welding

- Extrusion welding
- Friction welding

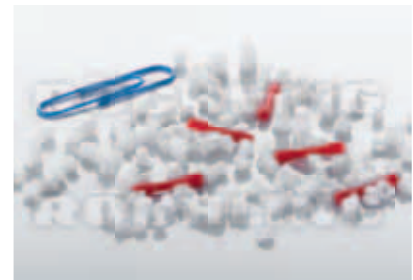

Micro-Machining

- Diameter: down to 0.5 mm
- Bore sizes to 0.1 mm
- Wall thickness as low as 0.1 mm
- Tolerances as tight as 0.02 mm



CNC machining centre
for components up to 14,000 mm long

Unlimited possibilities

Complex designs and narrow tolerances

Our high-precision CNC systems are equipped with dry and wet processing as well as internally cooled tools. This enables production of complex geometries and narrow tolerances, while at the same time maintaining a high degree of surface quality. In addition, we are also able to perform 5-axis machining. We also offer processing of other materials in combination with machined plastic parts.

Currently we have, among others, more than:

- 100 CNC milling machines
- 50 CNC lathes
- 15 automatic profiling machines
- and a wide variety of profile extruders with over 500 tools

Combined components

The workflows in our machining companies are also designed for the production and assembling of complete assembly groups. Thus, thread inserts, ball bearings or other inserts can be added in further processing steps and combined with other components into complete assembly groups.

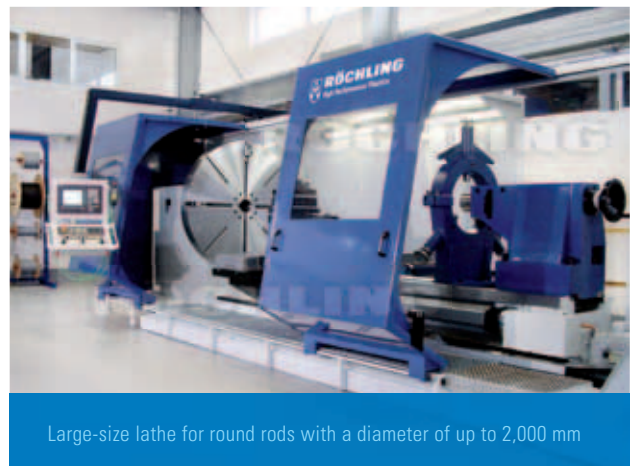

Large-size lathe for round rods with a diameter of up to 2,000 mm

Large dimensions

Sheave with a diameter of 2,500 mm

1,800 mm

0,0 mm

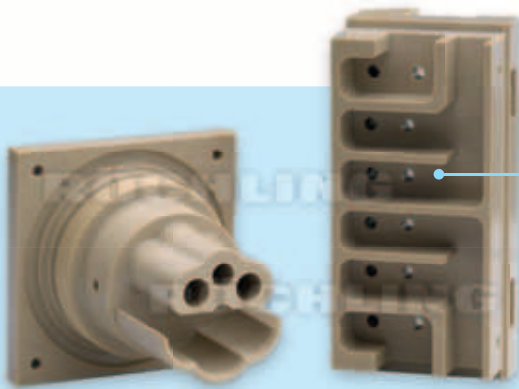
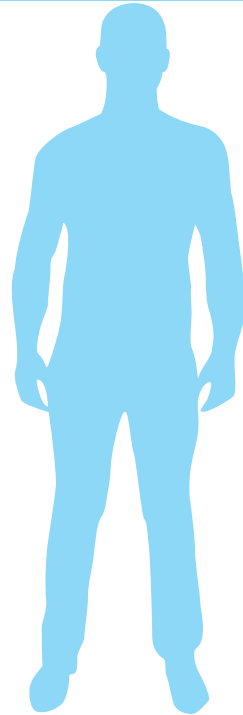

Complex design

Complex components machined to customers' drawings with close tolerances and with outstanding surface quality



Micro-Machining

Micro machined parts with diameter >0,5 mm
Scale 1:1

Plastics know-how from the semi-finished products manufacturer

Röchling counts among the leading manufacturers of semi-finished plastic products worldwide. We are not only concerned with the production of sheets, rods and profiles, but also with the particular requirements of the industries which we supply. Our logistics centres for semi-finished products are the largest in Europe and guarantee the fastest product availability.

We know precisely which material to recommend for your application. If necessary, we will develop special formulations for your application, to ensure you get the best plastic for your needs.

Outstanding material characteristics

We live in the "age of plastics". Plastics are customisable and have characteristic profiles that often surpass those of traditional materials such as steel, wood or concrete, which they increasingly replace. Today, there is virtually no industrial product that does not come into indirect contact with plastic components in its manufacturing process or contain them itself.



Important advantages of plastic over steel

- Low weight
- No corrosion
- Good sliding characteristics (self-lubricating)
- Thermically and electrically insulating



An unparalleled range

For more than 100 years Röchling has specialised in the processing of plastics. Today, the product range is comprised of more than 140 different types of plastics – from standard plastics to high-performance plastics for withstanding high operating temperatures. The wide variety of modifications and special developments is also unparalleled worldwide.

You can benefit from this offer and the knowhow of our excellently trained plastics experts, our technological leadership, own training centres and materials laboratories.

Röchling offers you a unique range!

- Extraordinary selection of semi-finished products
- Experienced plastics and industry experts
- Own materials laboratories and training centres



Important characteristics of plastics

- Excellent sliding properties
- High abrasion resistance
- High degree of resistance to aggressive chemicals
- Remarkable flexibility or mechanical strength
- High degree of impact strength
- Flame-resistant or self-extinguishing
- Electrostatically conductive, dissipative or insulating
- Non-ageing
- UV resistant
- Suitable for use with foodstuffs and in medical applications

High-performance plastics

150 °C

SUSTAPEI
SUSTASON PPSU
SUSTASON PES
SUSTASON PSU

SUSTAPEEK
SUSTATRON PPS
Vitrine® HTS
SUSTAECTFE
SUSTAPVDF
Polystone® PVDF

Engineering plastics

100 °C

SUSTAPPE
SUSTANAT PC

SUSTADUR PBT
SUSTADUR PET
SUSTARIN (POM)
SUSTAVACU (PA)
SUSTA GLIDE (PA)
SUSTAMID (PA)
SUSTAKON (PK)

Matrox®

Industrial plastics

TroBloc®
Astrawood® Cool

SUSTAABS
MAYWO (ABS)
MAYWO (PS)
Formaterm®
Rimito®
Trovidur® (PVC)
Trovicel® (PVC)

Polystone® (PP)
Polystone® M (PE 1000)
Polystone® D (PE 500)
Polystone® G (PE 300)
Polystone® E (PE-LD)

CubX®
Foamlite®
LubX®
Play-Tec®
Polystone® Marine-Tec
Polystone® SafeTec

amorphous

semi-crystalline

In addition to thermoplastics, Röchling also offers a wide product range of fibre-reinforced plastics. All Röchling materials are available for machining.

More value for our customers

- Product and materials development
- Modification of existing compositions
- Practical testing facilities
- Cooperation with scientists
- State-of-the-art materials laboratory



Research and development

Competitive advantages through innovation

At Röchling, our top priority is innovation. This allows us to present the market with product developments that provide our customers with competitive advantages.

We develop new products and manufacturing processes to fit the specific problem definitions of our customers in our excellently outfitted materials laboratory, and in close cooperation with suppliers, scientists and institutes. Our laboratories have access to more than 700 standards. Additionally, over 350 material tests are conducted.

Our quality management system is regularly inspected in audits in accordance with DIN EN ISO 9001 and its compliance ensured. Moreover, our products undergo ongoing controls in all phases of the production process.

We actively engage in serving the industries through our collaboration with numerous advisory boards and committees, and thus, help define the quality standards of the future.



Understanding customer applications

The specialist for your industry

Every industry has different requirements for materials and products. For this reason, we analyse in-depth the specific needs of our customers in the various industries.

Our goal is to develop products that are a perfect fit for the respective intended applications and to introduce new paths for achieving this.

In the following pages we present you with several practical examples for select industries.

Construction support

Upon request, we also assist you with the configuration and design of your plastic components. We know what different plastics can do and which types of processing are practicable from a technological perspective. As such, we provide you with support from the selection of materials, to the design on the most advanced CAD systems to the precise machining and customisation of a part that will function optimally for your application.

Our experts are here to assist you with all aspects of your project. We would be delighted to visit you and examine in detail your challenging task on site.

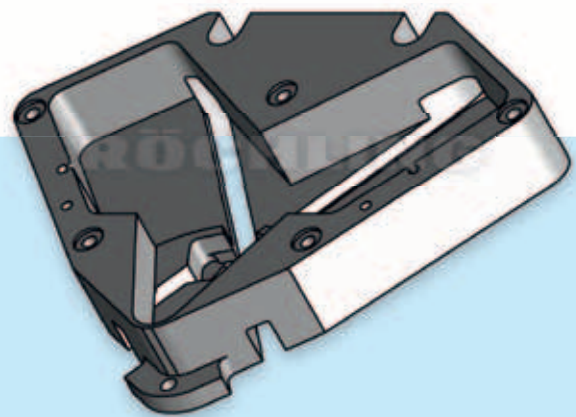
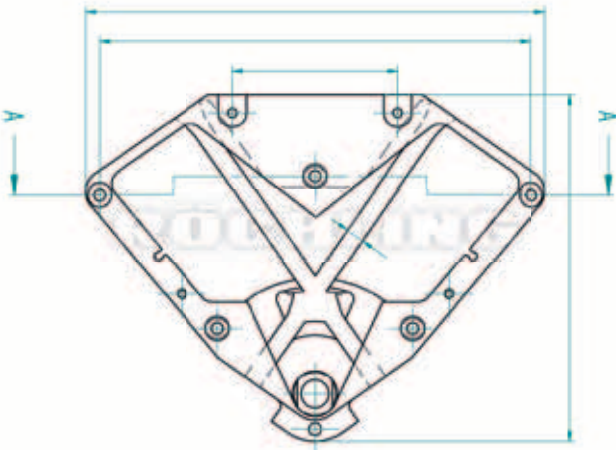

Our products and services

- Advice on plastic selection
- Review of constructions for functionality and producibility
- Technical product design on the most modern CAD systems
- Precisely fitting, bespoke parts



Advantages for you

- Cost savings in production and assembly
- Reduced material and parts costs
- Additional construction resources
- Optimum functionality



Röchling supplies materials with special properties for use in engineering and plants

- High impact strength
- Outstanding sliding characteristics
- Resistant to high temperatures
- Complex geometries

 **Engineering and plant construction**

Permanently ready for use

Even after heavy loads and countless operating hours, machines and plants must operate reliably. Machines and plants have different requirements on the materials used, depending upon the intended application: a high degree of impact strength, excellent sliding characteristics, use with high temperatures and parts with complex geometries.

Röchling has a great deal of experience in the manufacture of parts for plants and engineering. We would be delighted to advise you in the selection of the right material for your application.

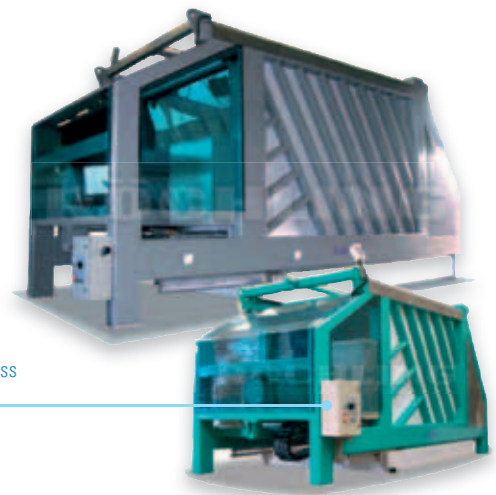

Grape press



Cutting boards

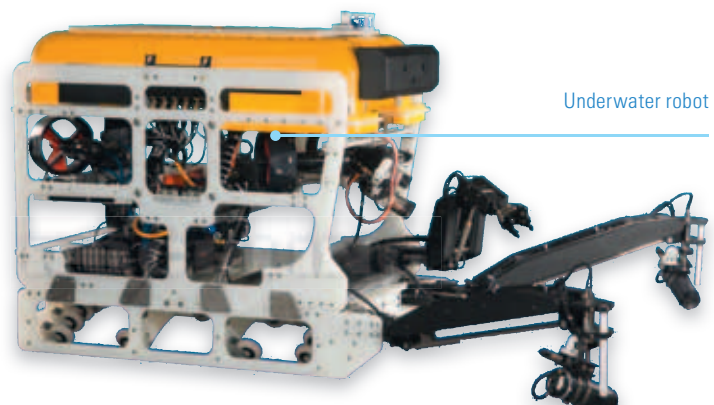

Underwater robot



Advantages of LubX®

- Energy-saving
- Coefficient of sliding friction can be reduced by up to 75 %
- Noise-reducing
- Suitable for contact with foodstuffs



Conveying system with chain slide rail made of **LubX® C**



Conveying screw made of **Polystone® M** soft is gentle on PET bottles



Beverage industry

LubX® saves energy

In the face of long-term increasing energy prices, the reduction of energy costs in production, storage and logistics processes plays an increasingly important role. The use of parts with optimised sliding friction in a conveying process can reduce the required conveying strength – and thus, the amount of energy used – to a minimum. In this way, the performance and efficiency of the plant can be significantly improved.

With our product family LubX® we have developed a high-performance sliding material especially for applications in materials-handling and automation technologies. Compared with conventional sliding materials, conveying systems equipped with LubX® C, LubX® S or LubX® CV need considerably less energy. The considerably lower coefficient of friction eliminates the possibility of the slip-stick effect (backsliding) almost completely and thus increases process stability.

Comparison of sliding properties

Sliding partner POM

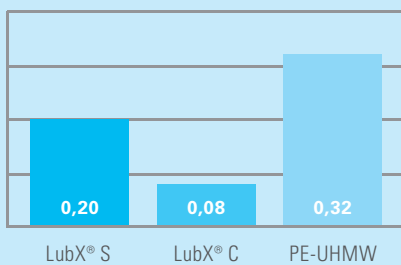

Sliding partner steel

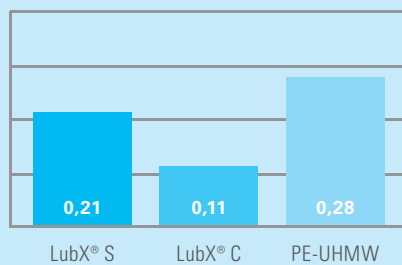

Sliding partner PET

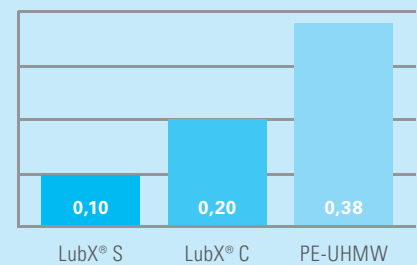

Coefficients of sliding friction under dry conditions / Validated on the application-related Röchling tribology test stand
Speed: 0.25 m/s, Surface pressure: 0.25 MPa, Test time: 24 h

Wear parts from Röchling stand for

- Extension of service life of a least one wear partner
- Customer-specific solutions through well-founded technical advice
- Few adjustments e.g. exchange of wear parts
- Current plant preserved e.g. no conversion of the paper machine

20 Patents
confirm our competency!



Paper industry

Worldwide leading partner for wear parts

The number one manufacturer of superior plastic wear solutions for the paper industry, we absolutely know the needs of our customers. We offer a complete range of high quality wear parts (a total of 100 different products depending upon customer requirements).

We intend to continually further develop the products with the goal of reducing the friction and wear on the product so that the service life of the product itself as well as that of the friction partners (e.g. screens/filters, felt) will be increased. This is achieved through continual improvement processes in product development and ongoing quality improvement.

The right selection of wear partners and materials can effect a positive change in the energy balance, without changes to the geometric shape and without technical conversions.

ROBASMART

With ROBASMART, Röchling has developed a new, "smart" product line. Components, such as seals, are fitted with sensors. These continuously deliver data to operators about the status of their systems. Until now, plant operators had to rely on experience. ROBASMART thus reduces maintenance times and increases efficiency.



Rubber-graphite sealing strip



Sealing elements in the dryer section



Ceramic dewatering elements



Röchling offers the food industry

- A broad spectrum of plastics in compliance with the EU regulations 1935/2004/EC, 10/2011/EU, 2023/2006/EC
- No negative influence on the health of the consumers and composition, taste, smell and appearance of the foodstuff



Food industry

For direct contact with foodstuffs

Röchling has several plastics designed especially for use in the food industry, which are suitable for direct contact with foodstuffs. These can be used in machines for the industrial processing of foodstuffs as well as cutting surfaces and boards. We ensure that our plastic products, which are intended for direct contact with foodstuffs, fulfil the requirements of the framework regulations 1935/2004/EC, 10/2011/EU as well as of 2023/2006/EC. Suitability for foodstuffs is verified via migration tests in accordance with regulation 10/2011/EU. The tests were

conducted on our products with all necessary stimulants under the strictest test conditions regarding temperature and test length.

This means you can be confident that the tested plastics are considered suitable for contact with all kinds of food as stated in our declarations of compliance. It goes without saying that our manufacturing processes are in line with „Good Manufacturing Practice“ (2023/2006/EC).



Transport elements in a packaging plant for Harz cheese



Conveyor system for fish processing



Cutting surfaces in a butcher shop



Plastics properties for efficient material flow

- Minimal sliding friction
- High degree of abrasion resistance
- Impact strength
- Antistatic properties



Conveyor technology and automation

For a smooth process

The intra-company transport of goods and merchandise must be quick, reliable and economical. Plastics from Röchling come as CNC machined components or milled and extruded profiles for use in e.g. conveyor and storage systems, chain or roller conveyors, pallet magazines or high bay shelving elements.

The special characteristics of plastics such as low sliding friction, high abrasion resistance, impact strength or even antistatic characteristics guarantee a reliable material flow and economical transport processes.



Roller Conveyor



Chain Conveyor



Rollers made of MOS2-filled SUSTAMID 6G wear less than steel



Medical grade products from Röchling stand for

- Biocompatibility in accordance with ISO 10993
- Chemical resistance
- Sterilisability
- Traceability
- FDA conformity
- Resistance to hydrolysis

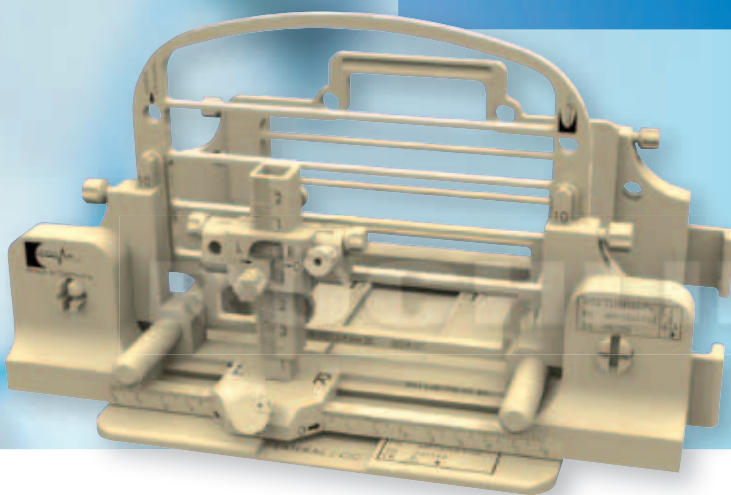

Breast biopsy unit manufactured entirely of **SUSTAPEEK**



Healthcare

Precision to the highest degree

Röchling is a strong partner of medical technology and knows best the requirements of this industry. Numerous high-tech processing machines guarantee the narrowest tolerances and perfect surfaces.

Along with standard materials for medical technology, we use the Röchling Medical Grade materials, which fulfil the requirements of the ISO 10993 for biocompatibility and which can be cleaned with common sterilisation and disinfection processes.

In addition, we have a comprehensive management system for the design and manufacture of medical devices in accordance with ISO 13485:2012.

We would be delighted to advise you about your parts development and the selection of the right materials. Just ask us. Our service package accelerates your development process, simplifies the approval of the medical devices and thus, reduces your costs.



Ball housing in shock wave therapy devices



Antimicrobial cladding



Filigree needle guidance



Filter and closing elements for hemodialysis



Polystone® PPs EL protects electronic parts



ATEX 95

Röchling provides plastics that meet the prerequisites for compliance with the explosion protection directive 94/9/EC ("ATEX 95")



Electronics

Comprehensive Product Range

Uncontrolled discharges can cause costly damages, particularly in microelectronics and potentially explosive atmospheres, which is why the electrostatic discharges (ESD) must be prevented.

Röchling offers a large selection of ESD plastics for industries that have requirements on the electrical conductivity of plastics. They have defined electrical properties – from antistatic to conductive.

Soldering masks

Röchling counts among the market leaders worldwide when it comes to the Durostone® PCB solder pallet materials and precise machining. For soldering of electronic parts the solder pallets are precisely adjusted to the layout of the PC boards. The soldering masks must remain dimensionally stable at high temperatures and be able to withstand thousands of soldering cycles.

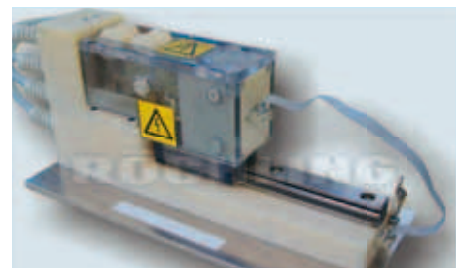

Part made of **SUSTARIN C ESD 90 PLUS**



Solder pallet for transport of PC boards

150 °C

High-Performance Plastics

100 °C

Technical Plastics

Standard Plastics

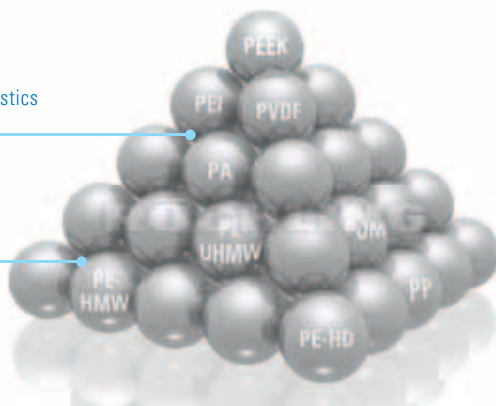

For all temperature ranges: Röchling Industrial offers a comprehensive range of ESD materials from PE to PEEK

Special properties of plastics in hydraulics and harbor construction

- Corrosion resistance
- UV resistance
- Impact and wear resistance
- Good sliding characteristics



Water and Harbor Construction

In use all around the world!

Contact with fresh water and salt water requires materials with extreme: corrosion resistance, UV stability, impact and wear resistance as well as slide characteristics. Our large machined parts, up to six metres, are in use all around the world in the construction of harbor plants and lock gate systems: for instance, in the expansion of the Panama Canal, the new construction of the Kaiserschleuse in Bremerhaven or the Ems barrier at Gandersum.

Fender systems

Mounted to fender systems, plastics serve as a sliding coat for ship hulls and protect quay bulkheads and ships during mooring, harbor manoeuvring and during idle periods.

Slide rails

Thanks to outstanding wear resistance the plastic slide rails are able to withstand long-term the strain of the steel doors in harbor locks, which often weigh several tonnes.



Watergate with slide rail



Fender on a quay wall



Blocking Systems



Economical advantages of Matrox over steel

- Reduced costs: approximately 60 % cheaper than structural steel
- Reduced weight: for a 200 m² silo Matrox provides a weight saving of 3 tonnes
- Longer service life: in sand-slurry wear tests Matrox achieved a value 46 % better than steel with an index of 80



Bunker lining

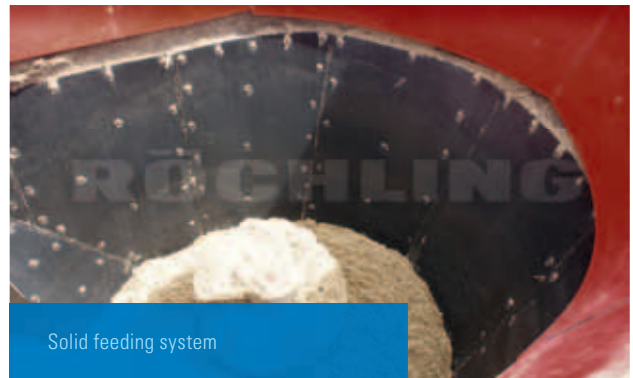

Solid feeding system



Bulk material handling

Matrox improves productivity

Everywhere, where bulk materials are transported, stored or further processed, wear and caking cause standstills in the work process. The flowability of the bulk materials is thus, of great importance for a smooth running procedure. Conventional steel surfaces become raw or start to corrode, so that the bulk goods begin to stick. This has a negative impact on productivity and process reliability.

With the Matrox family, Röchling combined the best surface friction with the highest abrasion resistance especially for use in lining technology. This improves the mass flow of bulk goods and prevents abrasion during the roughest conditions.

The products from Matrox are used as linings in a variety of industries that work with bulk goods: for example in mining, the transport industry, with storage and transshipment as well as the processing of bulk materials. We will recommend the right material from the Matrox family for your individual needs. Hereby, the durability and economic efficiency of the lining are paramount.

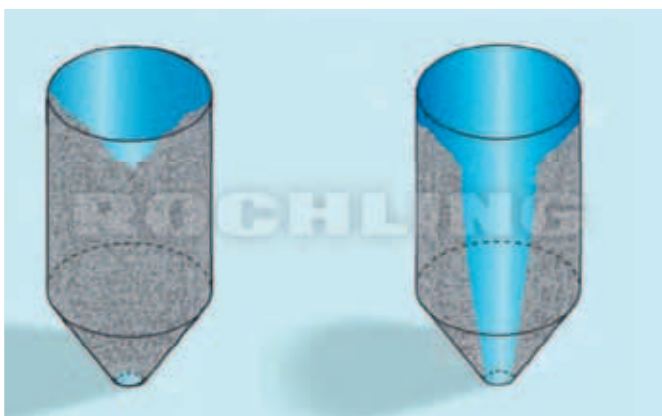

Silos without Matrox lining: bridge formation (left) and core flow (right) lead to production downtimes



Advantages of plastics in agricultural technology

- High wear resistance comparable to that of steel
- Significant weight savings
- Facilitates pulling
- Fuel savings
- No adherence of soil
- No splitting or breaking

Numerous patents

confirm our competency!



Agricultural technology

Pioneer in Plastics Wear Parts

Agricultural technology was dominated by metal for millenia. Unique manufacturing processes and the right choice of material have made us the leading supplier of plastic parts. Many well-known agricultural machine manufacturers rely on the competence of Röchling.

The use of technologically high-tech plastics in agricultural technology enables sustainability in soil cultivation through less soil compaction, fuel economy and improved efficiency.

The independent Austrian Federal Institute for Agricultural Engineering (BLT) in Wieselburg certifies to excellent test results for plough mould boards made of Robalon® in comparison to steel:

- Up to 13 % less tractive force
- Up to 14 % fuel savings



Grain lifters



Deflectors and skimmer plates

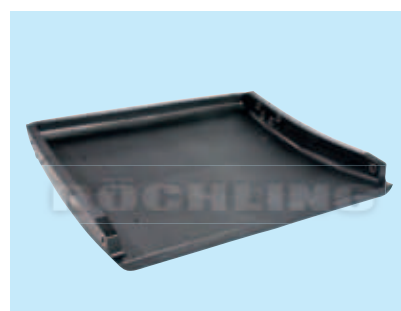

Skids for combine harvester



Materials from Röchling meet special characteristics for use in special vehicle construction

- High impact strength
- Outstanding sliding characteristics
- High abrasion resistance
- Resistance to lubricants



Special vehicle construction

Bespoke parts for special requirements

Röchling is your reliable partner when it comes to special vehicle construction. Our materials fulfil the custom requirements on parts for piste equipment, cranes or amphibious vehicles.

Piste equipment

Extreme temperatures and heavy loads require dependable materials, especially in the alpine business. Drive sprockets made of Robalon® in piste equipment transfer the engine power reliably to the snow, even on the steepest ski slope.

Cranes

In telescopic cranes slide elements made of SUSTAMID 6G in various sizes and geometries enable the telescoping of the boom and take up the high compressive forces with heavy loads.



Crane with slide element in boom



Weed harvester for waterway conservation with plastic parts on the chain drive



Drive sprocket in an alpine vehicle



Applications in the sports and leisure industry

- Play and leisure equipment
- Nursery facilities
- Signs and educational games
- Wellness area and swimming pool facilities



Sports and leisure industry

Precisely tailored solutions for numerous applications

Röchling is your competent partner for numerous applications in the sports and leisure industry. With our extensive experience we offer ideal solutions made of plastic for versatile ideas.

Röchling won't lead ice skating lovers onto thin ice: With special plastic panels, people are able to skate on a plastic ice rink that requires no cooling even in the summer. The high energy expenditure normally required in ice rinks for ice making and cooling are not necessary here.

We stand for made-to-measure solutions: our products are tailored to the particular requirements of each application and offer a long service life and bespoke quality.

We would be delighted to advise you regarding the development and implementation of your idea. Just ask us.



Overflow channel covers for a swimming pool



Play equipment made of plastic



Educational games for children



Siemens press picture

Special properties of plastics when using renewable energies

- Outstanding slide characteristics
- High degree of chemical resistance
- Excellent wear resistance



Renewable energies

Broad Product Range for Renewable Energies

A broad product range of our high-performance plastics are in use in the generation of wind and solar energy as well as in biogas plants. Our many years of experience as a supplier in traditional areas of energy production and distribution, for instance the generator, transformer and switchgear construction, is the basis for becoming the design partner and supplier for promising future forms of energy production.

Solar plants

Machined components from Röchling are slide bearings in the tracking of solar plants and ensure a precise adjustment of the solar cells to the altitude of the sun. Our products for solar plants are distinguished by a high degree of pressure resistance, UV resistance and a long service life.

Wind power

In wind power stations machined parts made of Durostone® fibre-reinforced plastics as well as of thermoplastics are taking over many mechanical, insulating or slide tasks and are replacing traditional materials such as steel or aluminium. Our product range for on-shore and offshore wind power stations includes bearings, shims, sealing rings or bearing housings for large ball bearings.

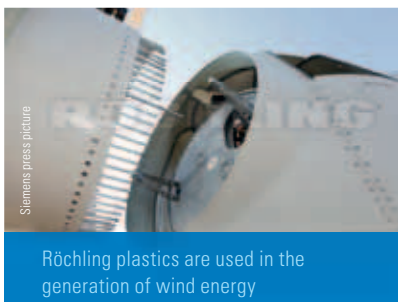

Siemens press picture

Röchling plastics are used in the generation of wind energy



Lining of a biogas plant



Tracking of solar plants

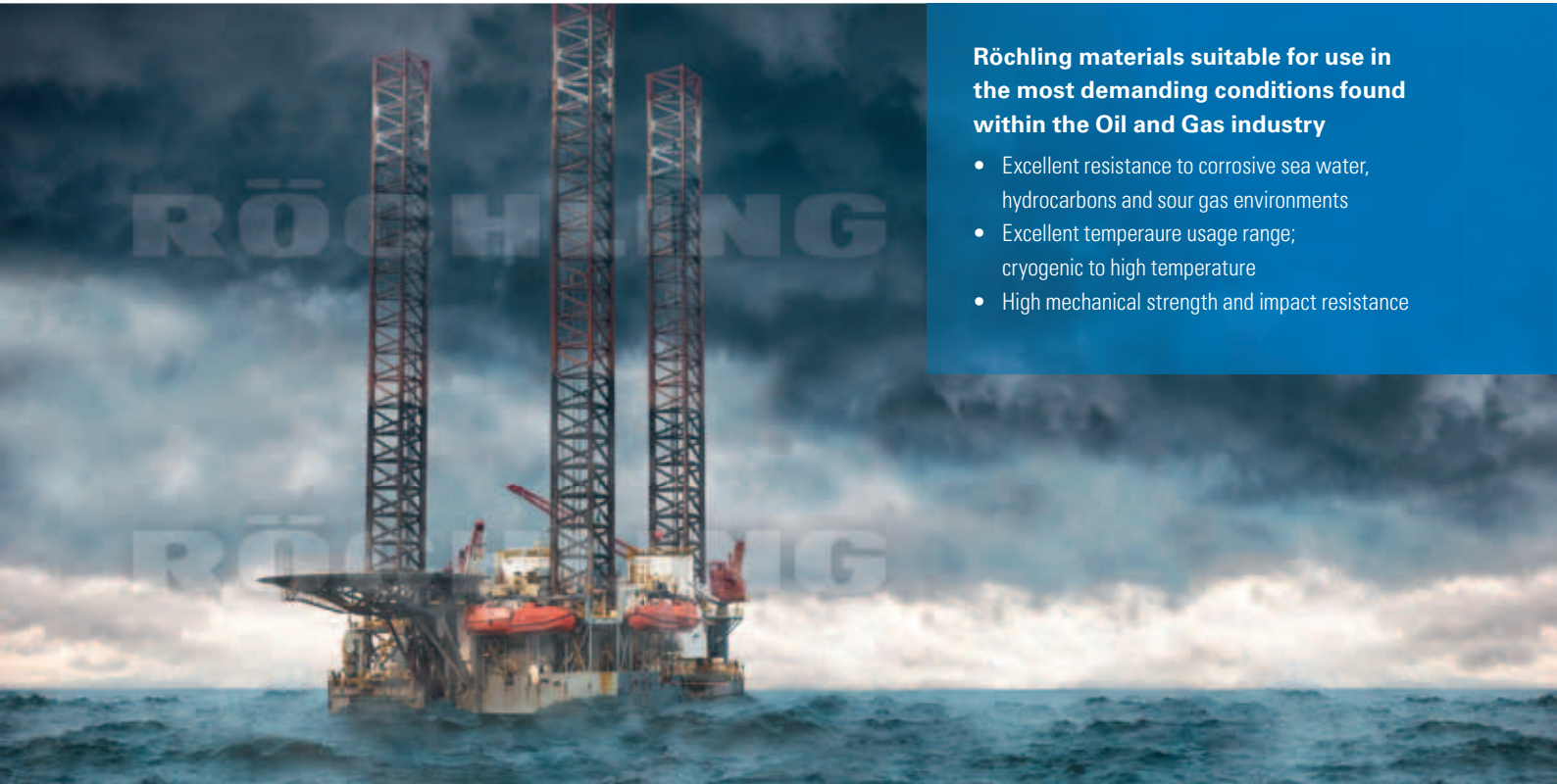

Röchling materials suitable for use in the most demanding conditions found within the Oil and Gas industry

- Excellent resistance to corrosive sea water, hydrocarbons and sour gas environments
- Excellent temperature usage range; cryogenic to high temperature
- High mechanical strength and impact resistance



Oil and Gas

Materials for the most demanding environments

The oil and gas industry operates in some of the most demanding environments on the planet, permanently exposing man and machine to extreme conditions. Including corrosive seawater, high mechanical loads, intense UV radiation, grease and other lubricants as well as exposure to both sweet and sour hydrocarbon environments.

Topside, Subsea, Downhole

Far from the mainland, operators must rely on plant and equipment to operate as designed for many years, at any time of day or night. For the use in oil and gas applications, our machined components offer you the highest level of reliability and durability. Whether topside, subsea or downhole: Röchling materials

have proven themselves in numerous applications to offer high mechanical strength, a broad temperature range of use, excellent resistance to corrosive salt water and to other fluids associated with oil and gas production. For example, oil and gas platforms, pipe supports, deep sea mining, seals and sensor assemblies.



Bend stiffener insert made from **SUSTAMID 6G**



Subsea tree end cap made from **SUSTARIN C**



Pipe supports made from **Durolight**



Subsea support structure (flange) made from **SUSTAPEEK**



SUSTAMID 6 FR from Röchling is flame retardant material for aerospace tested to:

- BSS 7239
- FAR 25.853
- FAR 25.855

Approved supplier to Airbus



Aerospace

High performance plastics for aerospace

As the drive to find weight saving opportunities to achieve operational cost reduction accelerates, plastic materials present a serious choice for design engineers. Our components machined from thermoplastics and composites offer you many benefits:

- Lighter than aluminium
- Can be self-lubricating for use in dry operating conditions
- More corrosion resistant than most metals
- Will operate in temperature from cryogenic to above 450 °C
- Lighter than glass, without loss of transparency

Housing for fueling system

Machined in tight tolerances housing for fuel systems made of SUSTAPEEK are resistant to fuels and suitable for a broad range of continuous use temperatures.



Valve in humidifier for passenger cabin made of PVDF

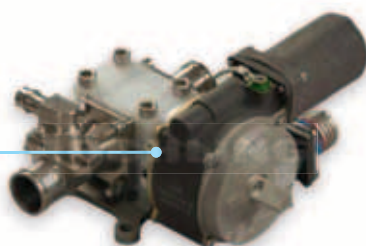

Valve housing for fueling system made of SUSTAPEEK



Bearing Cages made of SUSTAPEEK

Legal information

General information

All information contained in this delivery programme has been researched to the best of our ability. Despite our best efforts, this does not exclude the possibility of errors. For this reason, the information contained in this supply range is unconditional and carries no guarantees of any kind. Therefore, we assume absolutely no liability for any damages resulting from this information, nor any other form of liability, which in any way results from the information contained herein. We assume no liability for the completeness of the included products and information, processes, properties, etc. The specified values regarding weight is ascertained from many individual measurements as average values, which have been calculated using the thickness and the average mean of the tolerance measurements. This work is protected by copyright. Röchling reserves all rights, including those for the translation, reprints and the reproduction and/or excerpting herefrom. No part of this work is permitted to be copied, processed or distributed, regardless of intended purpose or medium, without the express written consent of Röchling.

Upon publication of this document all previous editions shall become void.

© 2018 Röchling

Applications of materials from Röchling for implants

The materials described in this supply range are not suitable for use as medical implants. Furthermore, these materials should not be used in medical-technical products, which would require long-term direct contact between the material and the patient.

Sterilisation and multiple applications with medical devices

For classification of the sterilisation resistance of our materials various criteria such as alteration of the mechanical properties, changes in weight or loss of transparency (amorphous materials) were used. For this reason, this evaluation constitutes a recommendation and makes no concrete commitments as to suitability of any material for a specific preparation process. In the event that the medical device is used multiple times, it is the responsibility of the product manufacturer to determine the suitability and the number of possible preparatory cycles permitted.





RÖCHLING

EUROPE

Germany

Röchling Engineering Plastics SE & Co. KG

Röchlingstr. 1 | 49733 Haren
Tel. +49 5934 701-0
Fax +49 5934 701-299
info@roechling-plastics.com
www.roechling.com

Röchling Lützen SE & Co. KG

Planckstr. 3 | 06686 Lützen
Tel. +49 34 444 308-200
Fax +49 34 444 308-100
kontakt@roechling-luetzen.de
www.roechling-luetzen.de

Röchling Hydroma GmbH

Lemberger Str. 101 | 66957 Ruppertsweiler
Tel. +49 6395 9222-0
info@roechling-hydroma.com
www.roechling-hydroma.com

Röchling Roding GmbH

Bayerschmidtweg 1 | 93426 Roding
Tel. +49 9461 4026-0
info@roechling-roding.com
www.roechling-roding.com

Röchling Sustaplast SE & Co. KG Formtechnik

Lahnstr. 22 | 56412 Nentershausen
Tel. +49 6485 889-0
formtechnik@sustaplast.de
www.roechling.com

Röchling Industrial Laupheim GmbH

Berblingerstr. 18 | 88471 Laupheim
Tel. +49 7392 978-0
info@roechling-laupheim.com
www.roechling-laupheim.com

Denmark

Röchling Meta-Plast A/S

Tøjstrupvej 31 | 8961 Allingåbro
Tel. +45 8648 1711
sales@meta-plast.dk
www.meta-plast.dk

France

Röchling Engineering Plastiques S.A.S.

2, Rue de Barcelone | 69153 Décines Cedex
Tel. +33 472 148960
roechling.decines@roechling-engineering.fr
www.roechling.com

Great Britain

Röchling Engineering Plastics (UK) Ltd.

Waterwells Drive | Quedgeley | Gloucester GL2 2AA
Tel. +44 1452 72-7900
sales@roechling-plastics.co.uk
www.roechling-plastics.co.uk

Röchling Fibracon Ltd.

Bowden Hey Road | Chapel-en-le-Frith
SK23 0QZ High Peak | Derbyshire
Tel. +44 1298 811800
info@fibracon.com
www.roechling-fibracon.co.uk

Röchling Insoll Ltd.

39 Wilbury Way | SG4 0TW Hitchin | Hertfordshire
Tel. +44 1462 450741
info@insoll.com
www.roechling-insoll.co.uk

Italy

Röchling Machined Plastics Italia s.r.l

Via Morena 66 | 28024 Gozzano
Tel. +39 0322 95421
info@roechling.it

Latvia

Meta-Plast S/A

Kapsedes Str. 2 | LV-3402 Liepāja
Tel. +371 6348 8539
letland@meta-plast.dk
www.meta-plast.dk

Austria

Röchling Leripa Papertech GmbH & Co.KG

Röchlingstr. 1 | 4151 Oepping
Tel. +43 7289 4611
robaproducts@leripa.com
www.leripa.com

Spain

Röchling Plásticos Técnicos S.A.U.

Ctra. Villena | s/n. - Apartado 34 | 46880 Bocairent
Tel. +34 962 350165
comercial@roechling-plastics.es
www.roechling-plastics.es

Czech Republic

Röchling Engineering Plastics, s.r.o.

Průmyslová 705 | 39111 Planá nad Lužnicí
Tel. +420 381 211-875
info@roechling-plastics.cz
www.roechling-plastics.cz

ASIA

China

Roechling Machined Components (Kunshan) Co., Ltd

No. 238 Chenfeng Road Kunshan City
Jiangsu Province 215300
Tel. +86 512 55132188
info@roechling-kunshan.com
www.roechling-rmc.cn

India

Röchling Engineering Plastics (India) Pvt. Ltd.

701, 'A' Wing | Leo Building
24th Road | Khar West | 400 052 Mumbai
Tel. +91 22 4217-8787
info@roechling-india.com
www.roechling-india.com

USA

Röchling Leripa Papertech LLC

710 Ford Street Kimberly | Wisconsin 54136
Tel. +1 920 954 9154
leripa.papertech@leripa.com
www.leripa.com

Röchling Machined Plastics

161 Westec Drive
15666 Mount Pleasant PA
Tel. +1 724 696-5200
rmp@roechling.biz
www.roechling-plastics.us



Röchling Industrial. Empowering Industry.

www.roechling.com